



PUMPS

YOUR PARTNER FOR PUMPING SOLUTIONS

PREMIUM IIOT-ENABLED
PUMP TECHNOLOGY

ANDRITZ

ENGINEERED SUCCESS



From then...

A large, vertical, cylindrical industrial component, possibly a turbine or generator part, is suspended in the air by a crane. The component has a complex, multi-sectioned design with a flared top and a side-mounted pipe. It is positioned in the center of a large industrial factory floor. In the foreground, two workers in blue uniforms and white hard hats are standing on a platform, looking at a large circular object on the floor. The background is filled with various industrial equipment, scaffolding, and storage racks, creating a busy manufacturing environment. The text "...to now" is overlaid in the center of the image.

...to now

ANDRITZ pumps technology for over 165 years

The international technology group ANDRITZ looks back on a long tradition as a manufacturer of machinery and industrial plants. Its pumps sector is one of the oldest divisions within the company. ANDRITZ pump engineers have been demonstrating for more than a century that tradition and innovation do not mutually exclude one another. On the contrary, the many years of experience in building hydraulic machines and the entire process know-how form the basis for the high standard of ANDRITZ pumps technology today.



DEVOTED TO THE MARKET RIGHT FROM THE BEGINNING

The efforts of the ANDRITZ Pumps Division to always provide innovative pump technology can be traced back to the beginnings of the company. In 1852, the company's founder, Josef Körösi, set up an iron foundry in Andritz, which at the time was a suburb of Graz, capital of the Austrian province of Styria, and laid the foundation for today's ANDRITZ GROUP. Soon after the company was established, the original program of metal goods was extended to also include water turbines and pumps. Around the turn of the twentieth century, this product range was enlarged once again when pumps for use in waterworks and pumping equipment for coal mines were added. Then ANDRITZ gained market leadership in the construction of high-pressure centrifugal pumps, which were so reliable that they were used in almost all of the large coal mines in the Austro-Hungarian Empire.

ANDRITZ PUMPS

Installation of a pump in the early days



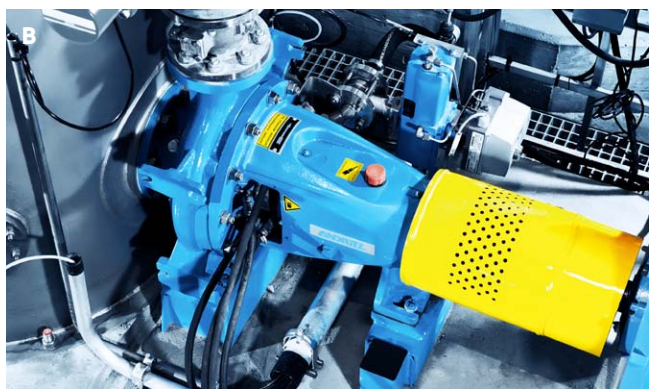
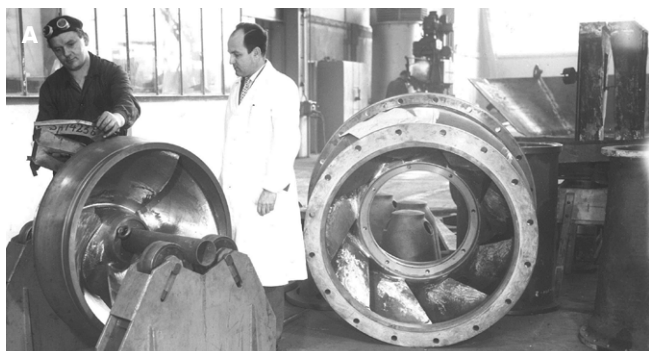

A Quality check of an impeller in the early days
B Modern ANDRITZ single-stage centrifugal pump operating as a process pump in a paper mill

In 1951, ANDRITZ embarked for the first time on the construction of complete paper machines in collaboration with the Escher Wyss Group from Switzerland.

EXPANSION OF OPERATIONAL INDUSTRIES - ENTERING THE PULP AND PAPER INDUSTRY

This picture of the initial success and constant expansion of the product range in the pumps sector continues into the present day. In 1951, ANDRITZ embarked for the first time on the construction of complete paper machines in collaboration with the Escher Wyss Group from Switzerland. Building on this basis, the Pumps Division forged ahead with its specialization in the pulp and paper industry. Ever since then, this has resulted in regular innovative developments. In 2007, for example, the existing series of medium-consistency pumps was revolutionized. For the first time, it was possible to operate a medium-consistency pump without a vacuum pump. This led to a substantial drop in maintenance requirements. In addition, valuable energy can be saved in the paper making with this new ANDRITZ medium-con-

sistency pump, which achieves efficiencies of over 70 percent. This and other pumps designed for the pulp and paper industry stand their test in projects around the world. At one of the world's largest single pulp lines, the UPM pulp line in Fray Bentos, Uruguay, energy savings of 7 to 15% were achieved with the new ANDRITZ medium-consistency pump in comparison to a competitor's pump formerly installed there. Control of the pump was highly simplified by using ANDRITZ's innovative fiber separation system, SMARTSEP. There has neither been a problem with degassing, nor any fiber losses since the start-up in November 2010. ANDRITZ holds a special position in the paper and pulp industry as the only pump manufacturer in the world that unites not only pumps but also the entire process and equipment technology under one roof. Benefiting from this know-how, the process pump series for this sector

has been completely redesigned and expanded in recent years. It now not only covers a wide range of applications, but also serves niches such as degassing pumps, self-priming pumps and pumps for the production of nonwoven material such as lyocell.

SUCCESS IN THE "TRADITIONAL" SECTOR – PUMPING WATER AROUND THE WORLD

In addition to activities in the pulp and paper industry, the Pumps Division has also enjoyed constant success in the water sector. Here it has specialized in building large irrigation and drainage pumps, amongst other things. In the sixties and seventies, ANDRITZ started up various pumping stations for irrigation, but also for the drinking water supply in the Middle East and Africa. Following Sudan's independence from British colonial rule in 1956, the World Bank supported the expansion of the locally evolving



ANDRITZ PUMPS

ANDRITZ engineers ensure long-lasting pump performance

sugar industry. As part of these historic developments, ANDRITZ has received the status of an exclusive supplier of electromechanical equipment and pumps for all major pumping stations ensuring the continuous agricultural irrigation. ANDRITZ has been active in Sudan for more than half a century. More than 130 ANDRITZ pumps are currently operating in the West African country without any service for more than 40 years. Together they convey more than 2,333,304 cubic meters of water per hour. An area of 420,000 ha is irrigated with ANDRITZ pumps in Sudan. This is an area equal to approximately 933,000 soccer fields.

Based on the knowledge gained from the execution of this and other large projects in the water sector, ANDRITZ launched a new double-suction split-case pump with efficiencies of more than 90 percent on the market. This pump is used to transport water or as a cooling and circulating pump in power stations, industrial plants, and in district heating networks. It features low pulsation and is thus also the optimum unit for use as a headbox pump in

the paper industry. This and other pumps from an extensive portfolio stand the test around the world. ANDRITZ supplied the world's largest horizontal, double-suction split-case pumps for the water supply to the megacity of Beijing. The Hui Nan Zhuang pumping station is fitted with eight ANDRITZ split-case pumps with a motor capacity of 7,300 kW. Three pumps plus one spare per unit, which can be activated immediately in an emergency, supply a total of 60 m³ of water per second over a distance of approximately 60 km to the Chinese capital. Other prestigious infrastructure projects such as drinking water supply to Atlanta, USA, flood control for Hanoi, Vietnam, irrigation for India or mine dewatering in Johannesburg, South Africa, are constantly adding up to the extensive project record.

ALWAYS ONE FLOW AHEAD

Behind these projects and other pump developments from ANDRITZ lies a modern hydraulic engineering laboratory on the company premises – the Anstalt für Strömungsmaschinen (Institute for Hydraulic Re-

search), known as ASTROE for short. Since being established in 1954, this ANDRITZ subsidiary has performed important development work with the aid of test rigs for water turbines and various types of pumps and provides facilities to conduct quality checks on hydraulic machines under different conditions at the highest international level. ASTROE, as a testing and inspection facility for hydraulic machines, also received state authorization to issue test certificates with public status in 1959 and has always secured ANDRITZ top international ranking in the field of hydraulic research.

ENSURING LONG-LASTING PUMP PERFORMANCE

Service and maintenance have a long tradition at ANDRITZ and complement the product portfolio. Founded in 1852, the international technology group can look back on centuries of experience in the maintenance and optimization of standard and large pumps. Today, this expertise is reflected not only in a service portfolio with innovative solutions and advanced products that can be optimally adapted to the respective customer needs, but also in a specially trained staff. The service employees are certified energy consultants for pumps and systems and have completed a particular training in pump hydraulics. In addition to maintenance, ANDRITZ specializes in the servicing of pumps to achieve improved efficiencies and adaptations to changed operating points of the installed pumps. A large potential for savings can already be achieved by improving the efficiency of 20 percent of the installed pumps. Regardless of the size and number of pumps, ANDRITZ covers servicing from the smallest standard pump in a pulp mill to the largest pump installed in a mega-infrastructure project. One

of the most prestigious projects in the recent history of the ANDRITZ service team was the order to supply a storage pump to an Austrian energy supply company. The original hydraulic machine was first put into operation in 1968. Until its retirement in fall of 2016, this pump had 7,600 start-ups, performed 52,600 hours of operation and pumped a total of 540 million cubic meters of water from a storage facility to a reservoir lake located the 906 meter higher. The offer of the international technology company was a new six-stage horizontal storage pump with significantly increased efficiency, delivery rate and thus performance. Compared to its predecessor, this pump achieves a significantly increased flow rate of 18 percent; thus from 2.73 m³/s to 3.32 m³/s. Likewise, the rated output increased from 27.2 MW to 32.29 MW and the head from 788 to 889.4 meters.

NOW AND IN THE FUTURE

As befits its international activities and the size of the projects handled, the ANDRITZ Pumps Division is a separate global division nowadays within the Group. By making strategic acquisitions like the hydropower division of VA TECH in 2006, GE Energy in 2008, and Ritz Pumps of Germany in 2011, ANDRITZ became a leading supplier of water and pump turbines worldwide. In addition to the water sector, the division also serves the pulp and paper, sugar, starch, mining, power and various other industries. With six locations across the globe and a global sales network, ANDRITZ Pumps offers everything from a single source – from development work to model tests, engineering, manufacturing and project management, commissioning, and on to after-sales service and training. This portfolio is completed with state-of-the-art IoT solutions.



High-quality and high-efficiency products as well as an understanding of different customer requirements have made ANDRITZ a preferred partner for pumping solutions around the globe.

ANDRITZ is a globally leading supplier of plants, equipment, and services for hydropower stations, the pulp and paper industry, the metal working and steel industries, and for solid/liquid separation in the municipal and industrial segments. Other important fields of business are animal feed and biomass pelleting, as well as automation, where ANDRITZ offers a wide range of innovative products and services in the IIoT (Industrial Internet of Things) sector under the brand name of Metris.

In addition to turnkey hydropower plants, ANDRITZ develops and manufactures high-quality large and standard pumps for many different industries and applications worldwide. These include pumps for large infrastructure projects for irrigation, desalination, and drinking water supply, for drainage of mines, as well as for the pulp and paper and the food industry.

A passion for innovative technology, absolute customer focus, reliability, and integrity are the central values to which ANDRITZ commits. The listed Group is headquartered in Graz, Austria. With over 160 years of experience, 25,600 employees, and more than 250 locations in over 40 countries worldwide, ANDRITZ is a reliable and competent partner and helps its customers to achieve their corporate and sustainability goals.

SELECTED HIGHLIGHTS

- 1900: Market leadership in the construction of high-pressure centrifugal pumps
- 1950s: Entering the pulp and paper industry
- 1960s: Beginning of the long-term pump and service supply to projects in Sudan
- 1970s: Installation of 11 pumps in Africa's biggest pump station in Sudan
- 1990s: Entering the Chinese market via joint-venture with Chinese pump manufacturer forms the basis of today's successful ANDRITZ Pumps location in Foshan, China
- 2000: Launch of ANDRITZ double-suction split case pump with efficiencies of over 90 percent
- 2006: ANDRITZ supplies the world's largest, horizontal double-suction split case pumps for the water supply to Beijing, China.
- 2007: Launch of ANDRITZ medium-consistency pump, which can be operated without a vacuum pump
- 2010: The world's largest medium-consistency pump went into operation at the UPM pulp mill in Fray Bentos, Uruguay.
- 2014: ANDRITZ delivers the world's largest submersible motor pumps for a Chinese mine
- 2016: ANDRITZ introduced a new high-pressure pump (HP 43) on the market with efficiencies of over 90% and stringent ecological alignment.
- 2017: ANDRITZ is set to deliver 27 vertical volute pumps to a mega infrastructure project in Telangana State, India.



A low-angle photograph of two technicians in white hard hats and safety glasses inspecting a massive, white industrial pump assembly. The pump has a large, circular, flange-like top section with a dark, textured interior. The background shows a clear blue sky and industrial structures, including a tall, silver, cylindrical tower. The overall scene is brightly lit, suggesting an outdoor or well-lit industrial environment.

**ANDRITZ Pumps offers
innovative and tar-
geted solutions with
pumps and complete
pumping stations.**

ANDRITZ pumps for your industry

PUMPS FOR THE WATER AND WASTE WATER INDUSTRY



Desalination
Waste water
Flood control
Transport
Drainage
Extraction
Municipal
Industry water
Irrigation

PUMPS FOR THE PULP AND PAPER INDUSTRY



Complete
pumps program
for the entire pulp
and paper
industry

PUMPS FOR THE FOOD INDUSTRY



Complete
pumps program
for the entire sugar
and starch industry
Pumps for food
applications
Bioethanol
Others

PUMPS FOR THE MINING AND MINERALS INDUSTRY



Mine dewatering
Water management
Process water

PUMPS FOR THE ENERGY INDUSTRY



Pump storage
Power cooling water
Pumps as turbines
Flue-gas desulfurization (FGD)

PUMPS FOR OTHER INDUSTRIES



Offshore
seawater lifting
Chemicals
Metals
Heating, ventilation, air conditioning
and refrigeration (HVACR)

Our longstanding experience in hydraulic machine manufacturing and complete process know-how form the basis of the high standard of ANDRITZ pump engineering.

Learn more about our
operative industries for
standard pumps >



Learn more about our
operative industries for
engineered pumps >





Double-flow submersible motor pumps HDM (Heavy Duty Mining) series

Industries: water, mining, other industries
Design: multi-stage, double suction submersible motor
Head: up to 1,500 m
Flow rate: up to 6,000 m³/h
Pressure: up to 150 bar
Temperature: up to 75 °C
Speed: up to 3,600 rpm



Learn more:



High-pressure pumps HP series

Industries: water, pulp and paper, power, other industries
Design: multi-stage, high-pressure
Head: up to 630 m
Flow rate: up to 850 m³/h
Pressure: up to 63 bar
Temperature: up to 140° C
Speed: up to 3,600 rpm
Efficiency: up to 90%

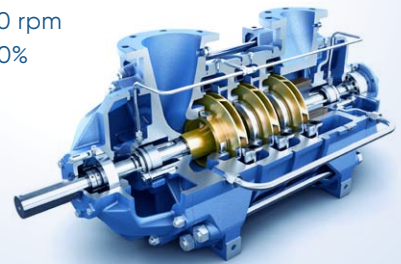

Learn more:



High-pressure pumps MP series

Industries: water, pulp and paper, power, other industries
Design: multi-stage, closed impellers
Head: up to 950 m
Flow rate: up to 400 m³/h
Pressure: up to 100 bar
Temperature: up to 160° C
Efficiency: up to 78%

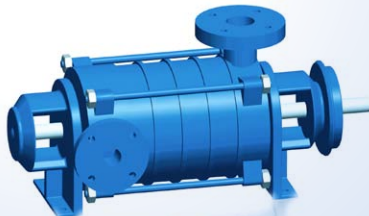

Learn more:



Medium-consistency pumps MC series

Industries: pulp and paper, food
Design: single-stage, single-flow, semi-open impeller
Consistency: up to 16%
Head: up to 190 m
Flow rate: up to 13,000 admt/d
Pressure: up to 25 bar
Temperature: up to 140° C



Learn more:





Multi-stage axial split case pumps ASPM series

Industries: water, power, other industries
Design: multi-stage axial split case pumps with various impeller arrangements in single or double flow design
Efficiency: highest efficiency available
Head: up to 1,000 m
Flow rate: up to 10 m³/s
Power: up to 40 MW

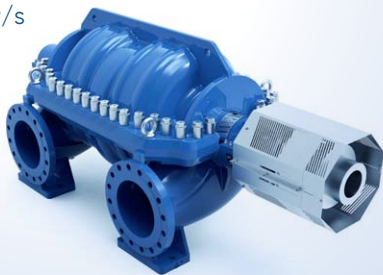

Learn more:



Pumps as turbines

Industries: power
Design: single-stage and multi-stage; single-flow or double-suction; open or closed impeller
Head: up to 80 m
Flow rates: up to 6 m³/s
Output: up to 2 MW



Learn more:



Self-priming centrifugal pumps AD series

Industries: water, pulp and paper, food, other industries
Design: single-stage, single-flow, semi-open impeller
Head: up to 190 m
Flow rate: up to 9,000 m³/h
Pressure: up to 25 bar
Temperature: up to 200°C
Efficiency: up to 88%



Learn more:



Sewage pumps, wet SW series

Industries: water
Design: single-stage, submersible, close-coupled
Head: up to 80 m
Flow rate: up to 2,600 m³/h
Pressure: up to 10 bar
Temperature: up to 40° C



Learn more:





Sewage pumps, dry SD series

Industries: water
Design: single-stage, channel impeller
Head: up to 100 m
Flow rate: up to 10,000 m³/h
Free passage: up to 200 mm
Pressure: up to 15 bar
Temperature: up to 140° C
Speed: up to 3,600 rpm

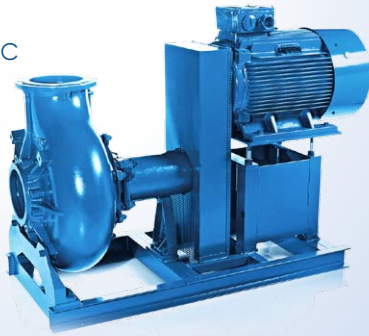

Learn more:



Sewage pumps, dry VP/CP series

Industries: water
Design: single-stage, single-flow;
semi-open vortex impeller
Head: up to 75 m
Flow rate: up to 1,800 m³/h
Free passage: up to 140 mm
Pressure: up to 16 bar
Temperature: up to 120° C



Learn more:



Submersible motor SM series (low-voltage motors)

Industries: water, mining, other industries
Design: water-filled and cooled three-phase asynchronous
Power: up to 700 KW
Voltage: up to 1,000 volts
Temperature: up to 75° C
Speed: up to 3,600 rpm



Learn more:



Submersible motor pumps SM series (High-voltage motors)

Industries: water, mining, other industries
Design: water-filled and cooled three-phase asynchronous
Power: up to 5,000 KW
Voltage: up to 14,000 volts
Temperature: up to 75° C
Speed: up to 3,600 rpm



Learn more:





Single-stage centrifugal pumps ACP series

Industries: water, pulp and paper, food, mining, power, other industries

Design: single-stage, single-flow, open and semi-open impeller

Flow rate: up to 9,000 m³/h

Head: up to 190 m

Temperature: up to 200° C

Consistency: up to 8%

Efficiency: up to 90%

Pressure: up to 40 bar

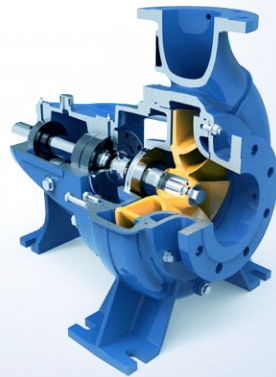

Learn more:



Single-flow submersible motor pumps, SU series

Industries: water, mining, other industries

Design: multi-stage, single suction submersible motor

Head: up to 800 m

Flow rate: up to 900 m³/h

Pressure: up to 100 bar

Temperature: up to 75 °C

Speed: up to 3,600 rpm



Learn more:



Split case pumps ASP series

Industries: water, pulp and paper, power, other industries

Design: single-stage, axial split case

Consistency (pulp and paper industry): up to 2%

Head: up to 250 m

Flow rate: up to 40,000 m³/h

Pressure: up to 25 bar

Temperature: up to 80° C

Power: up to 7,000 KW

Efficiency: up to 91%



Learn more:



Split case pumps for hot medium applications ASPH series

Industries: water, pulp and paper, power, other industries

Reference diameter: (DN) 100 to 1400, DIN EN1092 standard

Pressure classes: PN16/PN25, depending on application, size, and material

Flow rate: up to 30,000 m³/hr

Head: up to 180 m

Drive power: up to 7 MW

Efficiency: over 90%

Media temperature: up to 180° C



Learn more:





Vertical line shaft pumps

Industries: water, power, other industries
Design: pull-out or non-pull-out
Impeller: radial, mixed flow or axial; adjustable or fixed
Head: up to 80 m (single-stage) up to 120 m (multi-stage)
Flow rate: up to 70,000 m³/h
Power: up to 10,000 KW
Efficiency: highest efficiency available



Learn more:



Vertical submerged pumps SAT/CAT series

Industries: water, pulp and paper, other industries
Design: vertical, submerged, single-stage, single-flow, open or vortex impeller
Head: up to 50 m
Flow rate: up to 800 m³/h
Pressure: up to 16 bar
Temperature: up to 60° C
Consistency: up to 6%

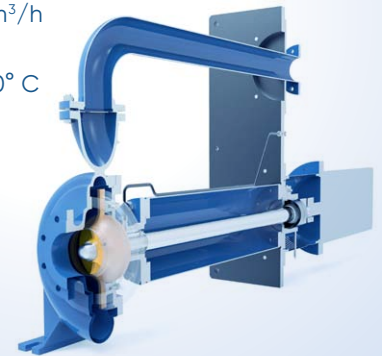

Learn more:



Vertical volute pumps

Industries: water, power, other industries
Design: metal or concrete volute
Impeller: radial or mixed flow
Efficiency: highest efficiency available
Head: up to 250 m (metal), up to 40 m (concrete)
Flow rate: up to 50 m³/s (concrete) up to 100 m³/s (metal)
Power: up to 140 MW (metal) up to 20 MW (concrete)

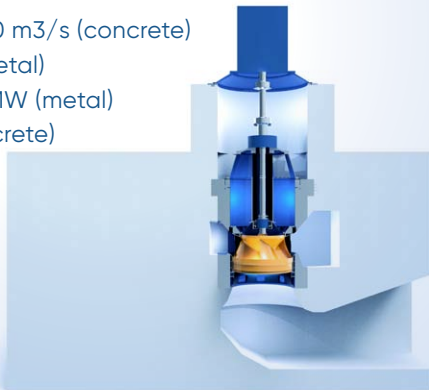

Learn more:



S-hydraulic kit

According to the global pump authoritative survey report, most of the pumps installed in plants operate at partial load because the pumps are oversized or conditions in the plant have changed. As a result, a large part of the energy is simply wasted. Thus, the new hydraulic upgrade kit has been developed to further improve our tried and tested, single-stage centrifugal pumps from the S series.

IT IS AVAILABLE IN THREE DIFFERENT OPTIONS: BASIC, CONVERT, AND PREMIUM.

Basic: An exchange of the impeller and liners in ANDRITZ centrifugal pumps, S series, which already operate in the optimum area. This results in an increase of efficiencies by 3-5% as well as a drastic reduction in the pumps' energy consumption, resulting in lower operational costs.
Convert: Additional exchange of the pump casing, impeller and liners of the pump, which operates in part load. This extends the pump's service life, and results in a huge increase of efficiencies by 5-10%.
Premium: The pump casing is specially prepared for ANDRITZ Industrial Internet of Things (IIoT) pump sensor, ensuring that the pump is all set for the next digital developments in the pump industry.

The background of the advertisement shows two men in blue work jackets standing in a factory. They are looking at a tablet held by the man on the right. The man on the left has his hand on his hip. The background is filled with industrial machinery and equipment, creating a professional and technical atmosphere.

PUMPS

**ANDRITZ EMPLOYEES ARE YOUR
RELIABLE PARTNERS PROVIDING
HIGH-QUALITY PUMPING SOLUTIONS
TO THE WORLD, REDUCING
ENERGY CONSUMPTION AND
ENVIRONMENTAL
IMPACT**



See for yourself!

ANDRITZ pumps for flood control in Vietnam

ANDRITZ supplies ten vertical line shaft pumps for the Yen Nghia flood control project in the vicinity of Hanoi, the capital of Vietnam.

Vietnam is one of the rainiest countries in the world. The majority of the rainfall is in the North of the South-east Asian coastal state. Although this area is actually characterized by a sub-tropical climate alternating between hot and humid summers and mild winters, on average it is the humid weather that dominates for eight months of the year. The peak of this phase is reached during the three-month rainy season in late summer and fall. In this period, the incoming monsoon causes heavy storms every year. In particular, heavy and steady rain caused rivers and streams to burst their banks, thus leading to flooding.

DANGEROUS FLOODS

In 2008, more than 100 people lost their lives due to floods in Vietnam. The capital city Hanoi, where 20 people were killed in the floods or by lightning, was particularly hard hit. In addition to these fatalities, the storms led to a shortage of clean drinking water and basic foods. After heavy rainfalls in 2013, more than 30 people died and more than 100,000 houses were flooded. In the period from October to November 2016, Vietnam was plagued by a total of three unusually violent storms. Floods again killed around 40 people and destroyed 100,000 houses as well as 1,300 hectares of rice fields.

In order to contain the severe effects of the annual period of rain and heavy storms, the Vietnamese ministry of agriculture and rural development launched numerous

flood control projects. The Yen Nghia project marks the beginning of this initiative. Until the end of 2018, the biggest flood discharge pumping station in the country will be built to the southwest of the capital Hanoi, with about 6.4 million inhabitants. ANDRITZ is supplying ten vertical line shaft pumps in the intended period from March to August 2018.

ANDRITZ CUSTOM-TAILORED ENGINEERED PUMPS FOR THE COUNTRY'S BIGGEST FLOOD CONTROL PROJECT

The Yen Nghia pumping station and the associated pumps are specially designed and built for the flood control application. This means that the pumps are only activated in case of need, but then have to work 100 percent. Their task is to transport large amounts of water at low head in the shortest possible time. Therefore, each pump has an axial hydraulic and extremely robust design in order to successfully defy diverse materials washed away by floods. Each pump conveys up to 15 cubic meters of water per second. If all ten pumps are activated, they can together transport up to 150 cubic meters per second. Thus, they would be able to empty the world's largest swimming pool (250 million liters) in the Chilean resort of San Alfonso del Mar in less than half an hour.

The scope of supply includes the construction, manufacture, transport, and installation supervision of the ten pumps in Vietnam as well as ANDRITZ original spare parts. The required

performance test of the pumps will be conducted at the test bench of the local Vietnamese company Hai Duong Pump Manufacturing JSC – or HPMC for short. HPMC is responsible for the supply of the entire electromechanical equipment for the Yen Nghia station. In the course of the collaboration on the largest pumping station in Vietnam, ANDRITZ has signed an exclusive distribution contract for large pumps with HPMC for Vietnam, Cambodia, and Laos. This forms the basis for receipt of further common projects in the future.

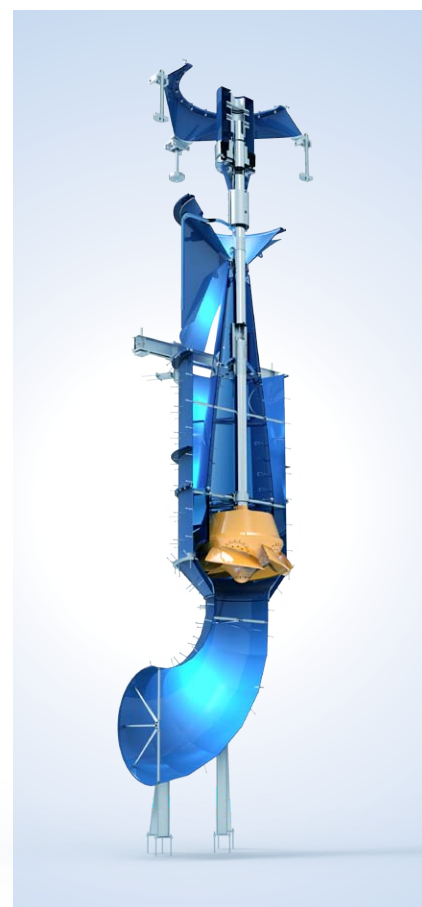

ANDRITZ vertical line shaft pump



10

VERTICAL LINE SHAFT
PUMPS SUPPLIED BY
ANDRITZ FOR THE
YEN NGHIA
PROJECT.

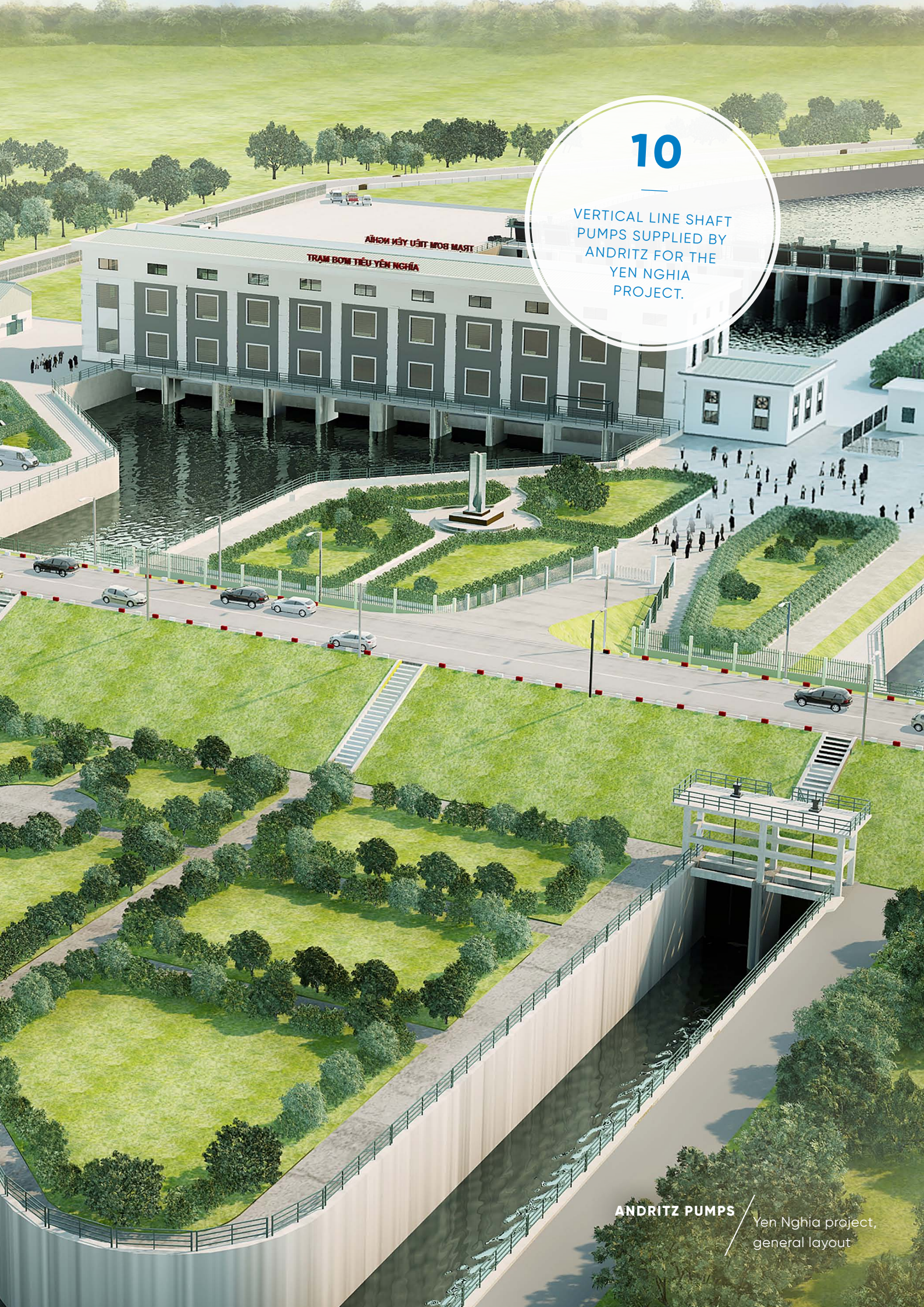

ANDRITZ PUMPS

Yen Nghia project,
general layout



VERTICAL VOLUTE PUMP

Storing about 4.7 trillion liters of water in order to irrigate 736,345 ha. The project Kaleshwaram is a unique irrigation project, not just in India, but worldwide. ANDRITZ will manufacture and supply 27 tailor-made vertical volute pumps for three pumping stations. Depending on the plant concerned, a single pump achieves heads between 25 and 107 meters and handles a flow rate of 31.1 to 83 cubic meters per second.

The largest head achieved is 107 meters, which is approximately the height of the Cathedral Church of Milan, while the pumps with the highest flow rate of 83 cubic meters per second could completely fill the Cheops Pyramid in Cairo, Egypt, within eight hours.





“The fact that ANDRITZ has such a long proven experience in heavy duty applications gave us the extra confidence to trust in ANDRITZ products. Our evaporation plants work only as good as the circulation is. Pumps are absolutely mandatory for our plants!”

Technical director of FBR ELPO

ANDRITZ PUMPS

Single-stage
centrifugal pump



Orange pumps with blue motors for the red juice

In the world-famous Italian town of Parma, the international technology Group ANDRITZ once again demonstrated its innovative strength and engineering skills. After only two years of preliminary work and numerous challenging tests, an exclusive framework agreement on the supply of centrifugal pumps was signed with FBR-ELPO, one of the most important producers of plants for tomato paste and fruit concentrate.

In spring 2014, ANDRITZ received its first order for centrifugal pumps for the production of tomato paste and juice concentrate. The request came from FBR-ELPO based in Parma, Italy. FBR-ELPO is a manufacturer of machines and complete lines for the processing of tomatoes and fruits and has been one of the international market leaders for over 50 years. Founded in 1963, the company was a small manufacturer of specifically custom-tailored machinery for the food industry. The company has always sought to acquire and increase its expertise in complex food applications. After only a short time, FBR was able to expand its position in the market internationally and to gradually gain access to more well-known companies as customers in the food sector. Today, FBR-ELPO offers a complete range of tomato and fruit processing solutions, from single machines to turnkey complete lines.

WHY ANDRITZ?

FBR-ELPO has always strived for the highest quality and performance to best serve its customers. In the light of the fact that existing suppliers and their products had reached their technological limits, the Italian company was looking for

a reliable partner with a global service network and top products.

Following brief negotiations in autumn of 2014, an agreement was reached on the basis of many discussions, factory visits and customer visits as well as careful studies of theoretic data. The aim was to determine if the single-stage centrifugal pumps from ANDRITZ's ACP series could meet the specific demands of the production process. First, these pumps have to deal successfully with the different varieties of the incoming raw product. Furthermore, depending on weather conditions, product quality can vary and this, of course, affects its media properties. So plants and pumps have to work under different conditions in the production process and are confronted with totally different media behavior and data.

The technical director of FBR ELPO states: "We found that ANDRITZ pumps behaved extremely constant in all conditions – this gives us an additional big value for our customer." FBR-ELPO customers include renowned companies such as Coca Cola, Danone, Dohler, Heinz, Nestlé, Smuckers, Unilever and many others. Based on the preliminary discussions, the decision was made to first test the ACP pumps in the tomato paste and juice concentrate production. Therefore, the first test pump was installed in a plant in Egypt. Due to the successful test, an exclusive framework agreement for the supply of centrifugal pumps was signed in spring 2016.

DYNAMIC SUCCESS

At the beginning of 2017, pumps for the project in Algeria were already delivered. In summer 2017, tomatoes flew through the custom-tailored orange ANDRITZ pumps with blue motors to be exported worldwide. The technical director of FBR ELPO explains the choice of ANDRITZ products: "The fact that ANDRITZ has such a long proven experience in heavy duty applications gave us the extra confidence to trust in ANDRITZ products. Our evaporation plants work only as good as the circulation is. Pumps are absolutely mandatory for our plants!" With a flow rate of up to 3,000 m³/h, the pumps used do not only operate significantly above the industrial average, but also already offer all the devices to be remotely serviced and operated by internet-of-people applications as part of an integrated, fully IoT-based application. This enables further optimization of production efficiency, realization of the lowest energy consumption and an early recognition of faults or power decreases.

The single-stage centrifugal pump, ACP series, with fluidizer is used in tomato production in a stainless steel version in order to process a concentrate with 30° Brix and a viscosity of 400 mm³/s. The machine must withstand an average temperature of 80° C permanently at a concentrated density of at least 1,100 kg/m³.



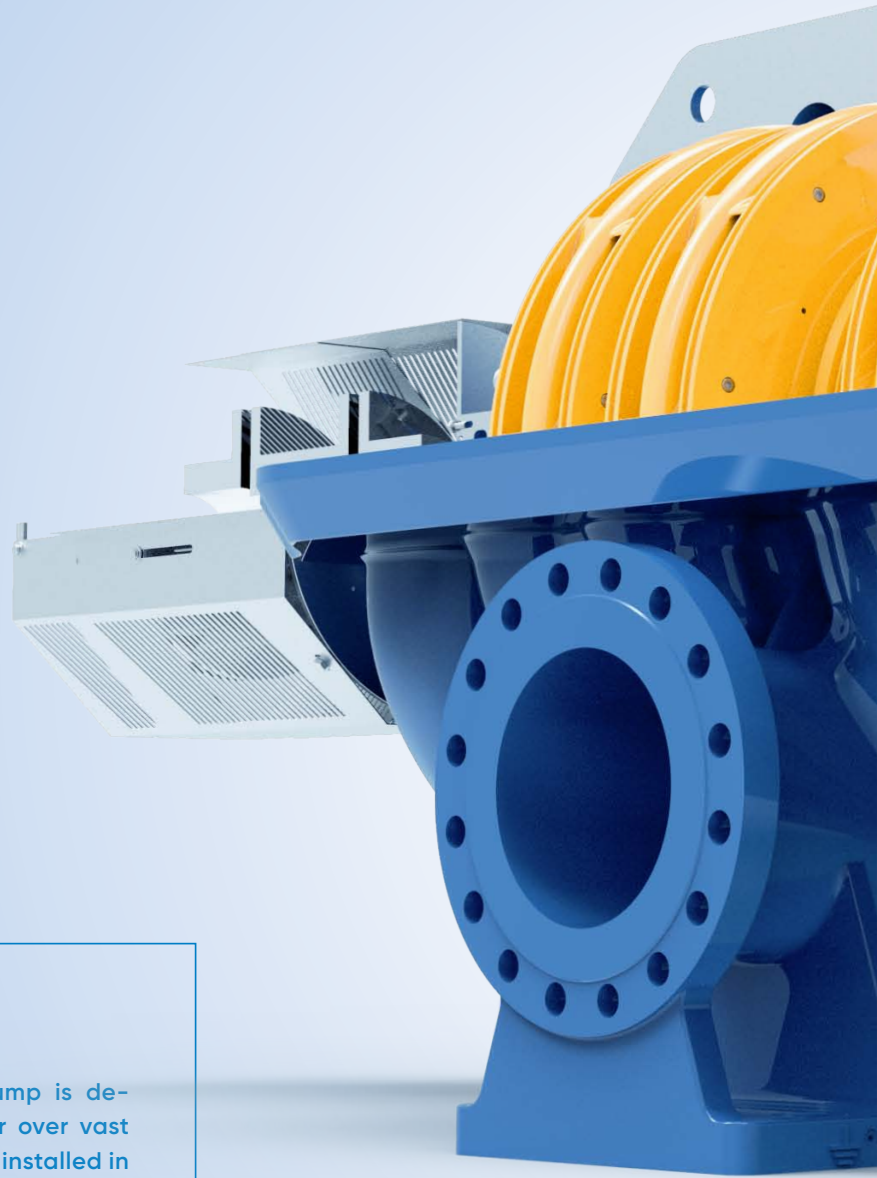

MULTI-STAGE AXIAL SPLIT CASE PUMP

ANDRITZ multi-stage axial split case pump is designed to deliver huge amounts of water over vast distances. This pump type is, for example, installed in a pumped storage project in Austria and is really second to none. It conveys almost 12,000 m³ per hour, or more than 3,300 liters per second, over a height difference of 880 meters. The discharge pressure equals unbelievable 120 bar and the machine, therefore, requires a 32 MW engine. These impressive statistics are completed by an efficiency of up to 91%.

Thus, theoretically, one of these pumps could easily fill five Olympic sized swimming pools at the top of the Burj Khalifa, Dubai, in one hour.

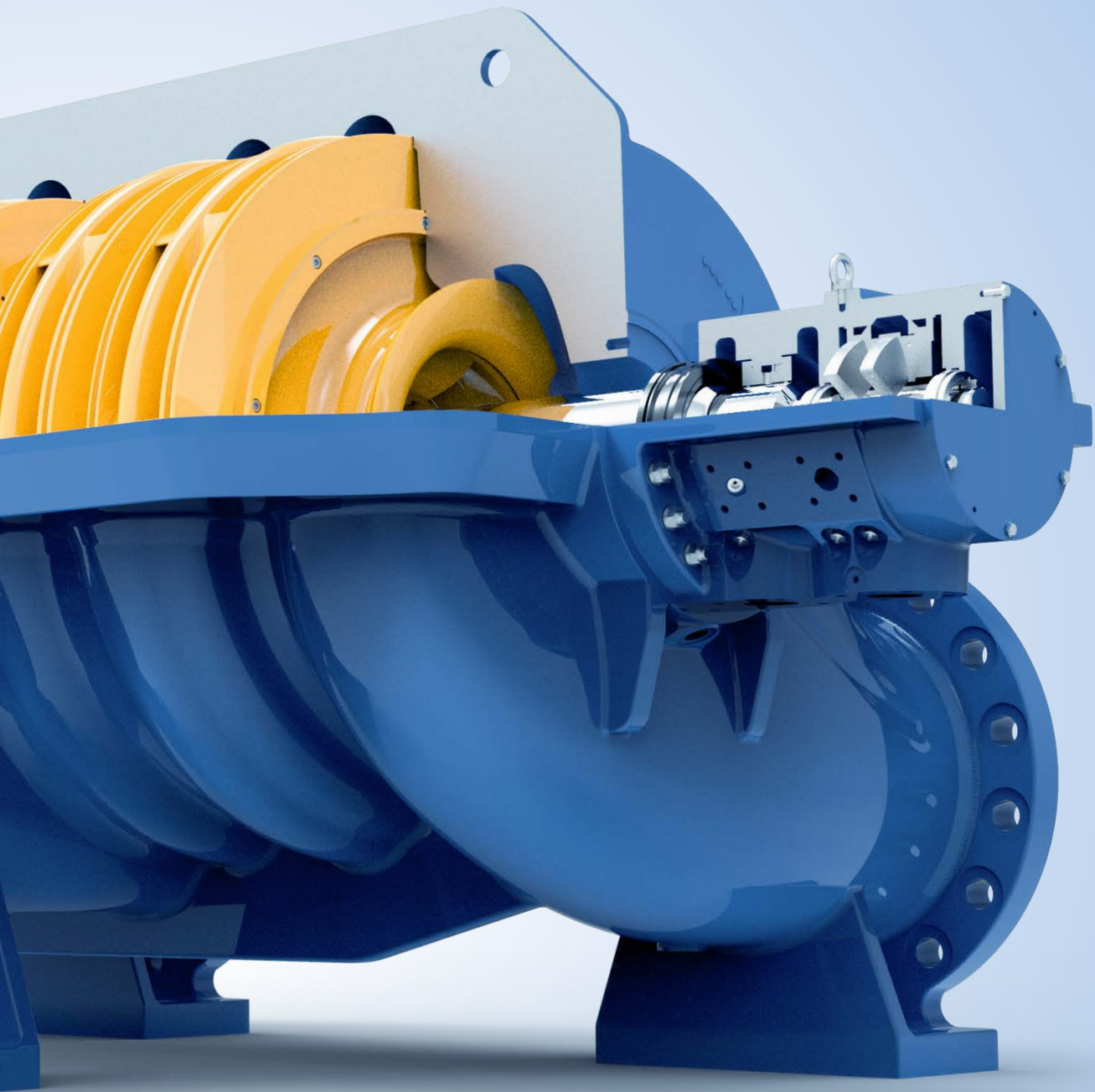

Pumps innovation for the Heinzl Group

Pumping solutions that make efficient use of fibers and energy.

After a record construction period of just over 13 months, the Heinzl Group's PM2 at Zellstoff Pöls AG, Austria, went into operation in November 2013. It is the largest and most advanced kraft paper machine in Europe. ANDRITZ had received the order to supply a PrimeLine plant for production of specialty papers. The scope of supply included the stock preparation plant, an approach flow system, the complete Fourdrinier paper machine, a high-precision drying cylinder, and the automation systems. ANDRITZ also supplied all of the process pumps for the new production plant. The investment increased the paper production capacity at the facility to 80,000 tons per year. The very high-quality bleached kraft paper is known under the brand name of Starkraft. It was no coincidence that the symbol chosen was a flying rhino – symbolizing both strength and flexibility. The kraft papers market segment is a highly specialized market with the highest

quality standards. Integrated production at the Pöls location not only ensures a continuous supply of raw material for the paper machine, but also contributes towards energy-efficient production.

HIGH-PERFORMANCE PULP PRODUCTION AND STOCK PREPARATION

The Zellstoffwerk Pöls pulp mill is currently able to produce 430,000 t/a and is the largest producer of bleached ECF long-fiber sulfite pulp in Central and Southeastern Europe. Every year, two million cubic meters of wood are processed, primarily in CO₂-neutral operations. The PM2 has two stock preparation lines. The first of them feeds long-fiber sulfite pulp produced at the mill to the paper machine, while the second stock preparation line supplies short-fiber pulp to the pulp cycle. This guarantees the optimum composition of raw materials for the demanding kraft paper production process.

The entire paper-making equipment is distributed over three levels: The pumps and the two stock preparation lines are installed on level one. The complete paper machine with finishing equipment and control room are on level two. In the side aisle of the paper machine building, the entire air system for the new plant is located on level three.

PUMPS DELIVERY PROGRAM FOR PM2 IN PÖLS

ANDRITZ supplied all of the process pumps for the new PM2 kraft paper machine at Zellstoff Pöls AG. The scope of supplies and services comprises the engineering work and supply of 30 stock pumps from the ACP process pumps series, six water pumps from the ISO series, two 'S' series stock and water pumps, two high-pressure pumps from the MP series, and two FP series double-suction fan pumps.

OPERATING RELIABILITY AND COST-EFFICIENCY

In addition to the supply of top-class equipment, professional and appropriate installation of the components guarantees trouble-free start-up and reliable plant operations in the long term. ANDRITZ specialists carried out the installation of the PM2 in Pöls, including the required precision alignment of the components, in close cooperation with the future operating personnel. Thus, it was possible to provide intensive training for future equipment operators and in-depth knowledge of the specific technical context.



Double-suction fan pump, FP series



heinzl
ZELLSTOFF PÖLS AG

THE SCOPE OF SUPPLIES:
30 STOCK PUMPS FROM THE
ACP PROCESS PUMPS SERIES,
SIX WATER PUMPS FROM THE
ISO SERIES, TWO 'S' SERIES
STOCK AND WATER PUMPS,
TWO HIGH-PRESSURE PUMPS
FROM THE MP SERIES, AND
TWO FP SERIES DOUBLE-
SUCTION FAN PUMPS.



THE KALESHWARAM
PROJECT IS A UNIQUE
IRRIGATION PROJECT,
NOT JUST IN INDIA,
BUT WORLDWIDE.

ANDRITZ PUMPS

Vertical
volute pump

Water, water, everywhere

Over recent years India, especially Telangana State, has been hit by extremely high temperatures creating problems for irrigation and crops, diminishing economic development and causing human tragedies. In 2016, about 1.4 million farmers left this region.

THE SACRED WATER

With a series of irrigation projects in the overarching Jala Yagnam project, the local government has undertaken measures to solve the irrigation problem for about 3.3 million ha of agricultural land. The traditional name Jala Yagnam translates as "worship of water" or "sacred water". The Kaleshwaram project is one of the largest sub-projects, designed to store about 4.7 trillion liters of water in order to irrigate 736,345 ha. This project comprises a dam and several pumping stations with reservoirs. Water is transported over a height of 500 m and a distance of 200 km. It is the first multi-stage lift irrigation project of this magnitude and complexity in India. It also contains the longest water transport tunnel in Asia, extending over a distance of 81 km connecting the dam to a reservoir. An irrigation project of this kind is unique, not just in India, but worldwide.

Such infrastructure developments are awarded turnkey as so-called EPC (Engineering, Procurement, Construction) projects in India. The EPC contract partners are usually large Indian infrastructure companies. In this type of contract, the basic requirement is that key components – in irrigation projects, these are the pumps and motors – are only supplied by qualified companies with a healthy balance sheet and good financial standing. In the Kaleshwaram project, the Indian infrastructure company Megha Engineering & Infrastructures Ltd.

(MEIL) is acting as EPC contract partner. Based on a joint overall solution for turnkey delivery of the key components – pumps and motors – ANDRITZ and its long-standing partner ABB were awarded the contract. While ABB Finland is supplying the motors, ANDRITZ will manufacture 27 vertical volute pumps for three pumping stations.

THE RETURNING PUMP SUPPLIER

International technology group ANDRITZ is a world market leader in the supply of plants, equipment, and services for hydropower stations. This portfolio also includes high-quality large and standard pumps used in infrastructure projects for irrigation, desalination, and drinking water supplies, for example. The ANDRITZ GROUP's Pumps division is supporting the Jala Yagnam infrastructure project in a total of eleven sub-projects. These include delivery of three vertical volute pumps for the Bheema project to irrigate 820 km³ (203,000 acres) of land and five volute pumps for the Kalwakurthy pumping station with a total flow rate of 115 cubic meters per second.

The pumps for the Kaleshwaram project are customized vertical volute pumps, each with an efficiency of up to 90 percent. The special feature of these pumps is that they are similar to turbines because of their size and integrated guide vane mechanism. The guide vane mechanism is adjusted by means of a hydraulic servomotor to suit the changing water level. This can achieve a large increase

in efficiency compared to normal pumps and lower energy consumption when the pumps are started up if the guide vane mechanism is closed.

In addition, a new hydraulic system with a particularly high specific speed of 400 NSQ and 600 NSQ (a measurement describing the ratio between flow rate, speed, and delivery head) was developed for the pumps in the first and second stations, taking account of the circumstances there. In addition, the weight of the impeller was optimized and the draft tube was downsized. Depending on the plant concerned, a single pump achieves heads between 25 and 107 meters and handles a flow rate of 31.1 to 83 cubic meters per second.

Besides design and delivery of the pumps and spare parts for them, installation and commissioning work on site will also be supervised by ANDRITZ personnel. Completion of the entire project is scheduled for June 2018. Harnessing sufficient water reserves for reliable irrigation of agricultural land will also bring about a long-term change for the better in the lives of farmers and everyone else in India's most populous state of Telangana.



A large white cylindrical pump is being installed within a complex steel framework. Several workers in safety gear are visible around the base of the structure. The scene is set outdoors under a clear blue sky. A circular callout box is overlaid on the image, containing text about the pump's capacity.

1,500 M³

OF WATER IS TRANSPORTED
TO THE SURFACE PER HOUR
IN EACH OF THE TWO
POWERFUL ANDRITZ
SUBMERSIBLE MOTOR
PUMPS.

ANDRITZ pumps dewater flooded mine tunnels in South Africa

Powerful ANDRITZ double-suction submersible motor pumps remove 1.5 million liters of water per hour from disused mines in the so-called “central basin” of Johannesburg.

In South Africa, ANDRITZ double-suction submersible motor pumps have been a gigantic lifesaver since 2014. In addition to the issue of water shortage, South Africa also faces the problem of acidic water in the former mines. For example, under the old gold mining town of Johannesburg is a lake of heavily contaminated water. This spreads horizontally and vertically in the abandoned mines of the former gold mines. This acidic mine water is an increasing problem. Rainwater seeps into the tunnels and chemically reacts with residual minerals such as pyrite, resulting in corrosive sulfuric acids. In the worst-case scenario, this can result in a pH of 2 sufficient to cause lasting damage to humans and the environment.

INNOVATIVE PUMP TECHNOLOGY TO PREVENT LASTING ENVIRONMENTAL DAMAGES

To counteract this horror scenario, two powerful ANDRITZ submersible motor pumps were installed in the so-called “Central Basin” of Johannesburg. Each pump is capable of transporting 1,500 cubic meters (= 1.5 million liters) of water per hour to the surface. Thus, 60 million liters of water per day are pumped out. With this achievement, it would even be possible to fill the entire pyramid of Cheops, the largest of the three pyramids of Giza, in Cairo, Egypt, in just over a month with water.

Due to the corrosive acid, the pumps have been tailor-made for the specific application. The design is based on the proven ANDRITZ HDM (Heavy Duty Mining) technology, the concept of a double suction pump. The thrusts produced are offset by the

counter-rotating arrangement of the impellers, and the pumps run without axial thrust, giving a properly maintained pump a service life of more than 20 years. Especially for this project, the system was supplemented by an encapsulation of the submersible motors. This technology makes it possible to create an internal pressure that is higher than the external pressure. Thus, the penetration of the corrosive water can be prevented and the components inside the engine are protected. This product feature is another of many small but significant, innovative aspects of this ANDRITZ product line.

21-TON GIANTS TO RETRIEVE THE GOLD MINES

These 21-ton giants, each 15 meters long with a diameter of one meter, are installed next to each other at a distance of five meters in the pit. Freely suspended on 430-meter long Duplex steel pipes, they transport the acidic mine water to the surface and on to an adjoining wastewater treatment plant where it is treated. The long-term goal is to lower the water level in the flooded mine so that it can begin mining gold ore again.

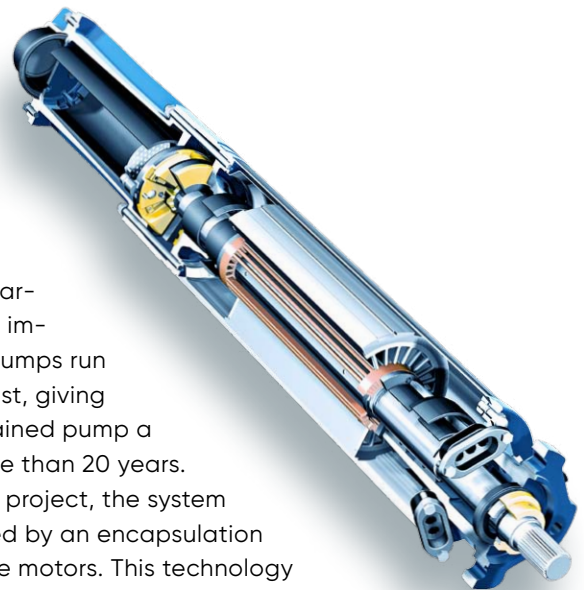



MEDIUM-CONSISTENCY PUMP

ANDRITZ medium-consistency pumps are made for the biggest pulp mills worldwide. Peak efficiencies of more than 70%, ease of operation, a variable-speed drive and low energy consumption make these pumps particularly efficient.

Just for fun, what would be the time required to pump all existing US dollar notes through the biggest ANDRITZ MC pump? According to the Board of Governors of the Federal Reserve System, there were 41.6 billion US dollar banknotes circulating in the USA by December 31st, 2017. The weight of one banknote is about 0.8 gram, which means the total weight of cash is 3328 tons in the USA. The daily capacity of the biggest ANDRITZ medium-consistency pump is 3500 air dry metric tons. Thus, it would take a single pump nine days to convey all the circulating cash in the USA.



Sweet pumps

ANDRITZ pumps are expanding the annual production capacity to up to 10,000 tonnes of sugar.

As a supplier of tailor-made pump solutions for the sugar industry, the international technology group ANDRITZ has an extensive knowledge of the necessary process technologies. This forms the basis for the development and production of reliable components for the sugar production. ANDRITZ centrifugal pumps can be used throughout the entire production chain and offer maximum efficiency and ease of maintenance. Due to their robustness, wear resistance through a wide variety of material combinations and the fact that they meet the highest customer requirements in terms of efficiency, service life, ease of maintenance as well as cost-effectiveness, sugar manufacturers all over the world rely on ANDRITZ centrifugal pumps.

SUGAR - THE STORY OF A RISING STAR

The consumption of sugar is almost as old as humanity itself. In Melanesia, Polynesia, the first traces of the cultivation of sugar cane for food use were found and date back to around 8000 BC. The first extraction and processing of sugar cane, however, took place only around 600 AD in Persia. For this purpose hot sugarcane juice, treated with a clarifying agent - a mixture of proteinaceous substances and lime -, was poured into wooden or clay cones, at the top of which the sugar crystallized

into a sugar loaf. For many centuries, sugar was initially just a medicine or a luxury item because the common people used the more affordable honey to sweeten food and drinks. Although modern sugar refining developed as early as the 16th century, it was not until the beginning of an industrial production from about 1850 that the sugar price fell. From then on, sugar became that popular mass agent. In the period from 2016 to 2017 alone, the annual sugar consumption was 181 million tonnes worldwide.

ANDRITZ - AN EXPERT IN THE SUGAR INDUSTRY

ANDRITZ already has numerous, convincing references in the sugar industry. In addition to these credentials, the pump division of the international technology group received due to their outstanding customer service in the course of

the project negotiations, the best price-performance ratio and the shortest delivery time and good relations of the local representative Reis Pazarlama ve Ticaret Ltd. Sti. to the customer, one of their most recent projects in this industrial sector. In April 2017, the respective customer commissioned ANDRITZ to supply 35 centrifugal pumps.

Since September 2017, 35 ANDRITZ centrifugal pumps have been operating in a sugar factory in Azerbaijan, about 20 kilometers from the Iranian border. ANDRITZ pumps are to expand their annual production capacity to up to 10,000 tonnes of sugar. Due to the great satisfaction of the customer with the high quality of the produced and delivered pumps, he purchased a complete ANDRITZ spare parts package just one month later, in October 2017.



Single-stage centrifugal pumps, ACP series

A satellite-style map of Azerbaijan is shown in shades of green and blue. A white circle with a thin black border is positioned in the upper right quadrant. Inside the circle, the number '35' is written in a bold, blue font. Below the number is a short horizontal line. Underneath the line, the text 'ANDRITZ CENTRIFUGAL PUMPS ARE OPERATING IN A SUGAR FACTORY IN AZERBAIJAN.' is written in a smaller, blue, all-caps font. A thin white line extends from the bottom left edge of the circle, pointing towards a small white dot on the map, which indicates the location of the sugar factory.

35

ANDRITZ CENTRIFUGAL
PUMPS ARE OPERATING
IN A SUGAR FACTORY
IN AZERBAIJAN.



ANDRITZ PUMPS

Three submersible
motor pumps for Atlanta

Safeguarding the water supply in Atlanta

Pumping stations transport water to one million people of Atlanta, USA.

Ever since it hosted the Summer Olympic Games in 1996, Atlanta – capital of the US state of Georgia – has been striving to modernize the city's infrastructure. One of the most prestigious and important projects in this campaign concerns the old Bellwood granite quarry in the north-western part of the city. This area is to be transformed into one of the largest drinking water reservoirs in the United States, with a capacity of 9.5 billion liters of water (2.5 billion US gallons). In addition to the construction work, the project also includes building two central pumping stations that will transport the water to the population of over one million in and around the city of Atlanta.

A PUMP STATION WITH SPECIAL REQUIREMENTS

One of these two pumping stations is the Quarry Pump Station, which pumps 40,834 m³ of water per hour (253 MGD) every day. This pumping station has an extremely low water level, which in turn creates complex general conditions for transporting the water. In this system, each submersible motor pump must be able to provide a constant capacity of 4,842 m³/h (30 MGD), also under fluctuating water surface levels with up to 36.6 m (120 ft) between minimum and maximum. In order to meet these requirements, the pumps must be driven by submersible motors with

a variable speed that allows the motors to operate at different speeds of between 885 and 1,081 r.p.m. In conventional pumping technology, this variable speed change results in fluctuating hydraulic forces that affect the rotating unit and would lead to an undefined dynamic load status of the axial thrust bearing.

THE ANDRITZ SOLUTION

Thanks to its technically superior, innovative, and very economical solution, ANDRITZ was awarded this strategically important contract to supply three submersible motor pumps complete with peripheral equipment for Quarry Pump Station. One of the most important



technological advantages of the suggested ANDRITZ solution to meet the special technical requirements is the use of submersible motor pumps in double-suction design. For this purpose, two impellers rotating in opposite directions are arranged one above the other and driven continuously by a pump shaft. This compensates in full for the axial thrust, regardless of the rotation speed. The hydraulic thrust forces acting on the pump, the motor, and the axial bearings, are completely neutralized.

The division of work between the two pump halves not only enables full compensation of the axial thrust,

but also halves the suction speed at the pump inlets. Each of the two pumps thus transports half of the flow to its center at full pressure. Splitting the flow reduces the suction speed of the flow medium along the inlet channels to the pumps and, ultimately, it also reduces the wear. In addition, the halved flow speed along the walls of the well has a very positive effect on the service life, especially with abrasive solids and sludge. In this way, the maximum possible operating reliability can be guaranteed, which increases the required maintenance intervals to up to 20 years and more.

SUSTAINABLE WATER SUPPLY FOR FUTURE GENERATIONS

This largest pump order so far for ANDRITZ in North America resulted from a joint venture together with PC Construction and H.J. Russel. Completion of the entire project is scheduled for 2019. Thanks to this drinking water reservoir, the city of Atlanta is guaranteeing a sustainable water infrastructure for future generations, among other things by using an innovative, economical, and also technically superior ANDRITZ pump solution.

Smart pumps

Founded in 1852, the international technology group ANDRITZ has launched its IIoT activities already back in 2005 and its basic activities in the automation sector began as early as 1984. Now, the company has combined its innovative Industrial IoT solutions, which are field proven in many reference plants, under the technology brand “Metris – Foresee digitally”.

Metris technologies include latest state-of-the-art industrial (IIoT) solutions as well as any kind of smart digital service and they can be fully tailored to individual customer requirements. Based on extensive and long-term experience as a supplier of technologies and systems for various branches of industries such as pulp and paper, hydro, metals or separations, ANDRITZ offers a broad portfolio of intelligent, digital solutions that provide significant help to customers in achieving their production and corporate goals. These can be fully tailored to individual customer requirements and unite our clients’ physical and digital worlds. By enabling customers to deploy and run leading-edge processes and products, ANDRITZ can look back on an extensive and, according to their clients’ feedback, impressive track record with annual savings of over more than 100 million euros for their customers.

With regard to IIoT solutions for pumps, ANDRITZ has set a key focus on ensuring continuous and sustainable operational reliability and performance of pumps and plants ever since.

ANDRITZ delivers highly sophisticated condition monitoring solutions for pumps, which are all based on the same agile API platform, called Metris. These solutions can be standard software packages or

tailored to specific customer request. Updates of the condition monitoring software are done regularly in order to assure backward compatibility with all saved datasets. These special pump monitoring packages comprise operating condition comparisons with shoulder curves. These include variable speed curves such as head, performance, motor power or NPSH versus flow curves. Additionally, temperature, vibration and electrical analyses are performed. All data can be analytically analyzed within the software or exported to various file formats. Limits and alert notifications with a traffic light system approach are also provided.

ANDRITZ offers its clients a standard set of industrial sensors. Furthermore, locally installed measurement devices and signals from control stations can be connected to the Metris Database via OPC/UI. Additionally, ANDRITZ monitoring system for pumps comes with industrial hardware such as a programmable logic controller, an iPC and an HMI for visualizing the pumps’ operation on site. Uplinks are provided to bring the data to the cloud.

The data is stored in an ANDRITZ Metris database, which is multidimensional and dynamic. It can be installed on a local server or remote in the ANDRITZ Metris cloud (Microsoft Azure). Metris cloud’s data are

accessible by both the client and ANDRITZ condition monitoring experts, which enables 24/7 service for the customer. Thanks to this, service recommendations for the operation of the plant and installed pumps can be given at any time. ANDRITZ Metris cloud is highly secured abiding by all internet security standards.

Finally, ANDRITZ Pumps provides optimization modules for pumps in plants, such as pulp and paper or pumping stations as well as remote control options for locally installed platforms.

Thus, ANDRITZ is taking pump and plant operations to the next level. By standardizing data acquisition with these tools, the customers’ experts can also communicate more effectively with ANDRITZ and improve plant performance at the same time. By connecting our customers’ specialists among each other as well with ANDRITZ experts, our IIoT technologies become the basis for Internet of People (IoP) solutions. This value-adding interrelation results not only in a professional preparation of the collected data improving and maintaining the plant’s performance, but moreover enables our customers to practice successfully applied business intelligence. That is why ANDRITZ IIoT solutions do not only make plants smarter, but also empower people.



A man wearing AR glasses is shown in a close-up, looking slightly to the right. The background is a dark blue with a complex, glowing geometric pattern of interconnected lines and triangles, resembling a network or data visualization. The overall tone is futuristic and technological.

IoP

ANDRITZ CONNECTS PEOPLE
THROUGH VR, AR, OPP, IDEAS
AND MANY OTHER TOOLS.
ANDRITZ IOP REDUCES COSTS
AND RISKS FOR OUR CLIENTS,
WHILE AT THE SAME TIME
SUSTAINABLY SUPPORTING
AND DEVELOPING THEIR
VALUABLE WORKFORCE.

Always a flow ahead - Research and development

Our affiliate ASTROE enjoys an internationally renowned reputation for its hydraulic developments and investigations. The high efficiency of the ANDRITZ pump series is ensured by Computational Fluid Dynamic (CFD) calculations and extensive testing carried out in our company owned laboratory.

Continuously increasing demands by customers in our operating industries emphasize the significance of R&D in the constant optimization of products and services. Today, efficiency, flexibility, and reliability over an extended lifetime are the major challenges of the market.

Our commitment to research and development forms the basis for our advances in hydraulic machine manufacturing. With ASTROE, center for hydraulic engineering and laboratory, we have an internationally renowned institute for hydraulic development work at our disposal. We are currently developing and testing our

pumps at five locations in Austria, Germany, Switzerland, and China. Our test stands are among the most accurate in the world. By networking these research and development centers, we provide a continuous transfer of know-how within the ANDRITZ GROUP for the benefit of our customers. The main tools for R&D are numerical simulation methods as well as experimental measurements in the laboratory and on site. State-of-the-art equipment, highly precise measuring instruments as well as the latest simulation technologies, and powerful software form the basis of the high technical quality of the pumps from ANDRITZ.



Greater efficiency for a competitive edge - Pumps service

Optimization / Modernization / Operating reliability

The conditions of your plant have changed, but your pumps are still operating as previously and therefore, wasting energy? Would you like to optimize your system to reduce costs? With ANDRITZ, you will have a competent partner for these and numerous other services at your side.

Service and maintenance have a long tradition at ANDRITZ and complement the product portfolio. The century-long expertise is reflected not only in a service portfolio with innovative solutions and advanced products that can be optimally adapted to the respective customer needs, but also in a specially trained staff. ANDRITZ has specialized in the servicing of pumps to achieve improved efficiencies and adaptations to changed operating points of the installed pumps. A

large potential for savings can already be achieved by improving the efficiency of 20 percent of the installed pumps. Our service team provides prompt, professional, and reliable assistance – also for other manufacturers' products. Book our service package and you can be sure of the best operating reliability for your systems in the long term. We conduct an expert assessment together with you, thus creating transparency and making an optimum solution possible that is tailored to your needs. After examining your plant, we determine its savings potential and realize it by improving the efficiency of the pumps installed. Additionally, this individual solution lowers your maintenance costs. You do not have to think about personnel, nor about maintenance schedules or utilities. Assembly is conducted according to defined schedules and with assistance from our trained personnel.



AN OVERVIEW OF OUR SERVICES

- Supply of original spare parts
- Deployment of trained personnel
- Installation and start-up
- Inspection
- Repairs, overhauls, maintenance
- Machine assessment by an expert for early fault detection
- Consulting and modernization
- Performance and vibration measurement
- Fault and damage analyses
- Feasibility studies
- Energy consulting for pumps and systems
- Preparation of maintenance schedules
- Service and maintenance agreements
- Automation and Electrical Power Systems
- Electronic equipment
- Training



Find out more about
ANDRITZ pumps service

PUMPS - A different pumps magazine

You are probably wondering what is behind the name "Pumps". ANDRITZ has top products and highly experienced as well as specialized employees. These are the success factors of the company and the two ingredients for this new magazine. Be different, that is what this magazine is aiming for. Within the four main categories – power, people, places, and pumps – pumps are presented from a new perspective thanks to exciting and diverse stories about ANDRITZ locations, employees and, of course, pumps. Every edition will focus on a different major umbrella term. The very first edition, for example, revolves

around the topic of hearts, whereas the second one deals with the subject salt. Regardless of the umbrella term, there are always fascinating, thrilling and unexpected stories, comparisons and facts. The magazine is released twice a year and is spread among everyone who is interested. Fairs, recruiting-events, presentations or corporate events are the most common places where one can grab one of the issues. The magazine, however, is also available on many more occasions as well as upon personal request (marketing-hpu@andritz.com). But see for yourself!

andritz.com/pumps-en/media/pumps-magazine





ANDRITZ PUMPEN

MASCHINENFABRIK
ANDRITZ
AGTIENGESELLSCHAFT

ANDRITZ PUMPS

Passion since 1852.
Brochure cover from 1950.

Graz-Andritz Austria



INNOVATION SINCE 1852

The internationally renowned ANDRITZ GROUP has been building pumps for more than 165 years. We offer innovative and targeted solutions with pumps and complete pumping stations. Our longstanding experience in hydraulic machine manufacturing and complete process know-how form the basis of the high standard of ANDRITZ pump engineering. Our quality and high-efficiency products as well as our understanding of customer requirements have made us a preferred partner for pumping solutions worldwide. ANDRITZ offers everything from a single source – from development work, model tests, engineering design, manufacture and project management, to after-sales service and training. We also perform complete start-up on site and guarantee our customers the best support. Our declared goal is your complete satisfaction. See for yourself!

EUROPE

ANDRITZ AG
Stattegger Strasse 18
8045 Graz, Austria
p: +43 316 6902-2509
f: +43 316 6902-413
pumps@andritz.com

ANDRITZ Ritz GmbH
Güglingstraße 50
73529 Schwäbisch Gmünd,
Germany
p: +49 7171 609-0
f: +49 7171 609-287
ritz@andritz.com

NORTH AMERICA

ANDRITZ INC
5405 Winward Pkwy Ste 100w
Alpharetta, GA 30004 USA
p: +1 770-640-2500
f: +1 770-640-9454
pumps@andritz.com

SOUTH AMERICA

ANDRITZ HYDRO S.A.
Av. Juruá 747, Alphaville Industrial
06455-010, Barueri, SP - Brasil
p: +55 11 4133-0000
f: +55 11 4133-0037
bombas-brazil@andritz.com

ASIA

ANDRITZ (CHINA) LTD.
No.83 B Zone, Leping Central Techno-
logy & Industry Park, Sanshui District,
Foshan 528137, Guangdong, P.R.China
p: +86 0757 6663-3102
atc_pumps@andritz.com

ANDRITZ Separation & Pump
Technologies India Pvt. Ltd.
S.No. 389, 400/2A & 400/2C,
Padur Road, Kuthambakkam
Village, Poonamallee Talluk,
Thiruvallur District –
600124, Chennai, India
p: +91 44 4399-1111
pump.in@andritz.com

ANDRITZ.COM/PUMPS



All data, information, statements, photographs and graphic illustrations in this leaflet are without any obligation and raise no liabilities to or form part of any sales contracts of ANDRITZ AG or any affiliates for equipment and/or systems referred to herein. © ANDRITZ AG 2018. All rights reserved. No part of this copyrighted work may be reproduced, modified or distributed in any form or by any means, or stored in any database or retrieval system, without the prior written permission of ANDRITZ AG or its affiliates. Any such unauthorized use for any purpose is a violation of the relevant copyright laws. ANDRITZ AG, Stattegger Strasse 18, 8045 Graz, Austria.

Want to learn more?
Scan – Send – Get

